

2734 Banning Road
Cincinnati, OH 45239
(513) 923-3777
(513) 923-1111 fax



Porter Precision Products

Blank Button Sketch Tool

Porter@PorterPunch.com or PorterPrecision@bellsouth.net

660 James Road
Alpharetta, GA 30004
(770) 751-7234
(770) 751-7238 fax

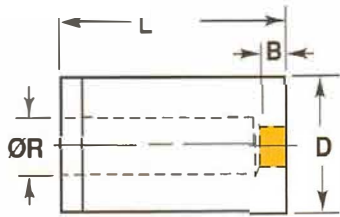

**Press-Fit
C'Bore Relief**

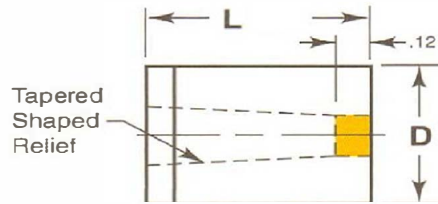

**Press-Fit
Tapered Relief
Press-Fit Precision
Tolerance**

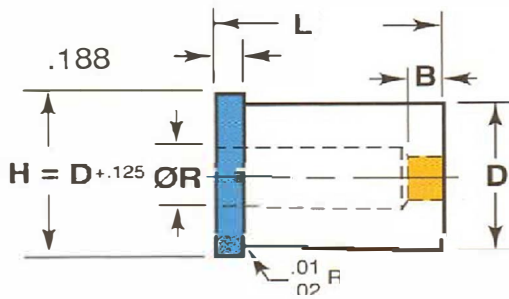

**Headed
C'Bore Relief**

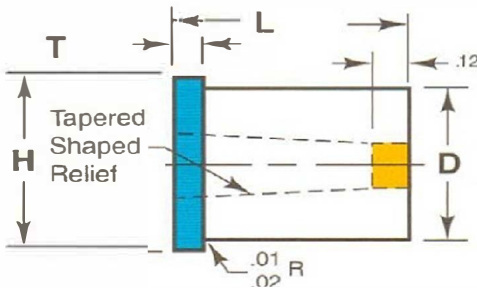

**Headed
Tapered Relief
Headed Precision
Tolerance**

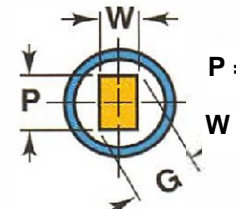
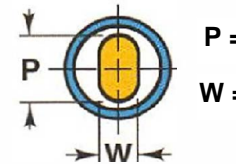
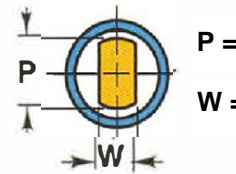

Locating Devices

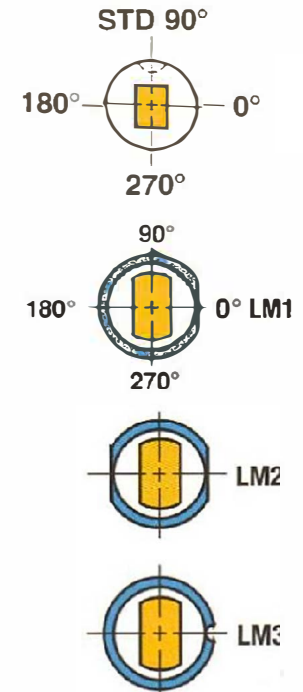

LM3 Std Dowel is .125 Dia.
Custom Dowel Size (Dia.)

*All tolerances will be held to industry standards unless otherwise specified

See page 38 of our catalog for further details on keying devices

Company Name		Tool #		Part#/Det#		Description (Porter Precision Products)	
Body Dia "D"	Length "L"	Material	Nose Length "B" or L2	Coating	Locating Device & Location	"T" if not Std (Xtreme)	
Notes and or other Alteration requests							Qty